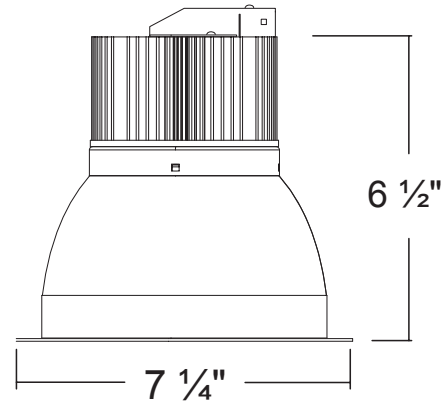
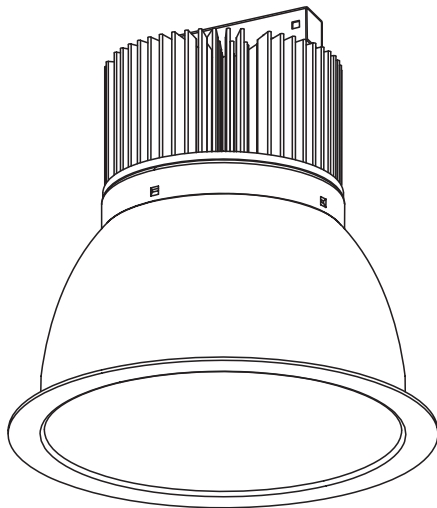

HOUSING MODEL :		TYPE
TRIM MODEL :		
PROJECT :		
PREPARED BY :	DATE :	

SERIES SPECIFICATIONS
TLD6TR SERIES

The TLD6 series are high grade LED high lumen down lights with a deep cone reflector that is designed for commercial lighting. These 6-inch, LED down lights are loaded with innovative features and options.

LINE DRAWING

CONSTRUCTION

Material
Aluminum

Flange
Self-flanged

Heat Sink
Diecast aluminum

Finish
Haze

ELECTRICAL

Input Wattage
31.08W

Color Temp.
3000K/4000K

HOUSING MODEL :		TYPE
TRIM MODEL :		
PROJECT :		
PREPARED BY :	DATE :	

ELECTRICAL (Cont.)

CRI 90	Lumens 2206
Efficiency 71 lm/W	Dimming Type 0-10V
Dimming Range 10-100%	Operating Temp. -30°C ~ 40°C
Frequency 50/60Hz	

CERTIFICATIONS/WARRANTY

Listing UL Listed	Location Rating: Suitable for damp locations
Title 24 Title 24 compliant	
Warranty Guaranteed for three years from the purchase date of the product, against mechanical defects in manufacturing.	

ORDERING INFORMATION

Sample Part Number: TLD6TR2830K-HZ

TLD6TR	28		-HZ
SERIES	WATTAGE*	COLOR TEMP	OPTIONS
TLD6TR	[28] : 28 Watts	[30K] : 3000K	[-HZ] : Haze
		[40K] : 4000K	

NOTES

Housing and Trim must both be purchased in order to complete the lighting fixture.
 *Housing and Trim wattages must match.