



CONTRACTOR:	
PROJECT:	DATE:
PREPARED BY:	MODEL#: TCOSB390BZ

SERIES SPECIFICATIONS



TCOSB390BZ

3 Spoke Bracket @ 90

FEATURES AND SPECIFICATIONS

Finish
Dark Bronze

Warranty
1-year limited warranty.

EPA Rating
0.5

LINE DRAWING

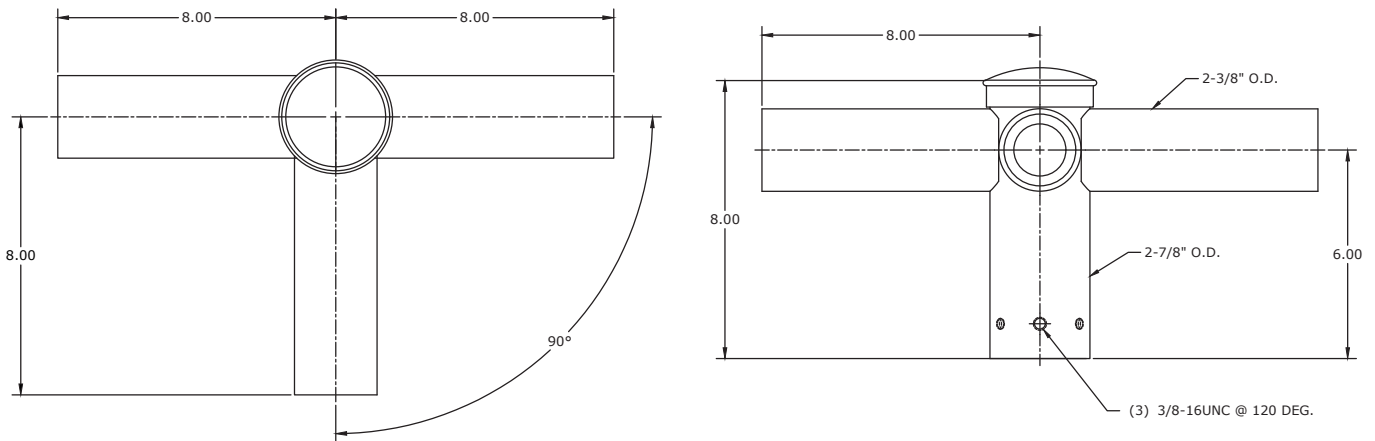

APPLICATION AND PERFORMANCE SPECIFICATION IS SUBJECT TO CHANGE WITHOUT NOTIFICATION