

CONTRACTOR:	
PROJECT:	DATE:
PREPARED BY:	MODEL#: CH-6-WSCS-WH-UZTD-G2

SERIES SPECIFICATIONS



CH-6-WSCS-WH-UZTD-G2

Properly replace commercial-grade recessed downlights with the unbeatable longevity and energy efficiency of LED. The built-in spring clips hold onto drywall directly allowing the CH series to be installed without a frame, making installation faster and more cost effective.



CONSTRUCTION

Housing Material: Aluminum

Mounting Style: Spring Clips

Lens Material: Polycarbonate

Location Rating: Suitable for wet locations

Listing: ETL Listed, Energy Star Certified

Finish: White

Warranty: Guaranteed five years from the purchase date of the product, against mechanical defects in manufacturing.

LINE DRAWINGS

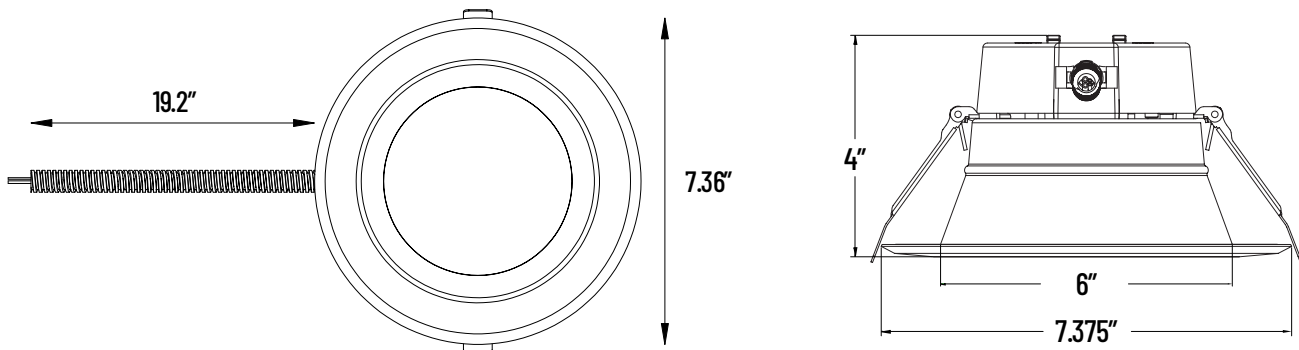

ELECTRICAL SPECIFICATIONS

Input Voltage: 120-277V

CRI: >90

Input Wattage: 14/18/24W

Efficacy: 83lm/W

Power Factor: >0.9

Beam Angle: 85°

Frequency: 50/60Hz

Dimming: 0-10V

Lifespan: 50,000hrs.

Color Temp.: 3000K, 3500K, 4000K, & 5000K

Min. Starting Temp.: -4°F (-20°C)

THD: <20%

Lumens: 1100/1500/2000lm

Max. Temp.: 104°F (40°C)



CONTRACTOR:	
PROJECT:	DATE:
PREPARED BY:	MODEL#: CH-6-WSCS-WH-UZTD-G2

ORDERING INFORMATION

Example: CH-6-WSCS-WH-UZTD-G2

SERIES	SIZE	WATTAGE	COLOR TEMP.	FINISH	DIMMING
CH	[-6]: 6"	[-WS]: Wattage Selectable	[CS]: Color Selectable	[-WH]: White	[-UZTD-G2]: Dimmable, Gen2

COMPATIBLE DIMMER LIST

BRAND	DIMMER TYPE	MODEL
Leviton	0-10V	DS710
Leviton	0-10V	IP710
Lutron	0-10V	NTSTV-DV
Lutron	0-10V	NFTV
Lutron	0-10V	DVTV-WH
Legrand	0-10V	H4FBL3PW

APPLICATION AND PERFORMANCE SPECIFICATION IS SUBJECT TO CHANGE WITHOUT NOTIFICATION