

CONTRACTOR:	
PROJECT:	DATE:
PREPARED BY:	MODEL#:

DESCRIPTION



ICL Series

Tamlite Lighting's ICL6ATQ 6" LED dedicated IC housing is designed for new construction installations and suitable for use in ceiling where the housing can be in direct contact with insulation. Air tight construction reduces energy costs by reducing the amount of air leakages through the ceiling.



FEATURES & SPECIFICATIONS

Material

Galvanized Steel

Bar Hanger

Adjustable from 13 5/8" to 25" Repositionable 90°

Knockouts

(1) 1/8", (6) 7/8"

For Use With

120/277V LED Retrofit Kit/mechanical defects in manufacturing.

Pryouts

(4) Romex pryout w/ strain relief

Ceiling Cutout Size

6.31"

Listings

ASTM

Certified under ASTM-E283 for Air Tight construction

Title 24

Meets state of California title 24 requirement.

cULus Listed for Feed Through

cULus Listed for Damp Location

Warranty

Guaranteed for one year from the purchase date of the product, against mechanical defects in manufacturing.

LINE DRAWING

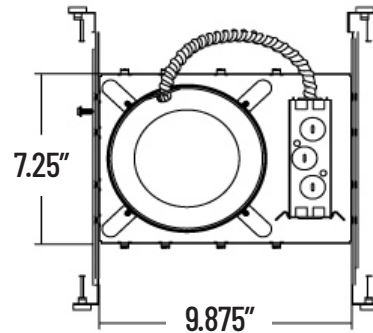
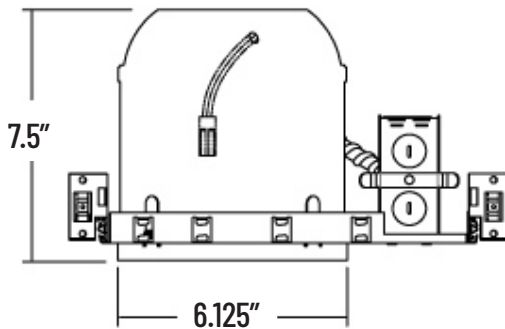



CONTRACTOR:	
PROJECT:	DATE:
PREPARED BY:	MODEL#:

ORDERING INFORMATION

Example: ICL6ATQ

SERIES	SIZE	HOUSING	CONNECTOR
ICL	[6] : 6"	[AT] : Air Tight	[Q] : Quick Connect

APPLICATION AND PERFORMANCE SPECIFICATION IS SUBJECT TO CHANGE WITHOUT NOTIFICATION