

MODEL :		TYPE
PROJECT :		
PREPARED BY :	DATE :	

SERIES SPECIFICATIONS

IC SERIES

The IC4IJ is a recessed LED light integrated with its own electrical junction box. This LED light requires no additional recessed housing or junction box to install into a ceiling. The mounting tabs offer quick and easy installation into any ceiling type. Its slim profile is also a great solution for shallow ceiling applications.



LINE DRAWING

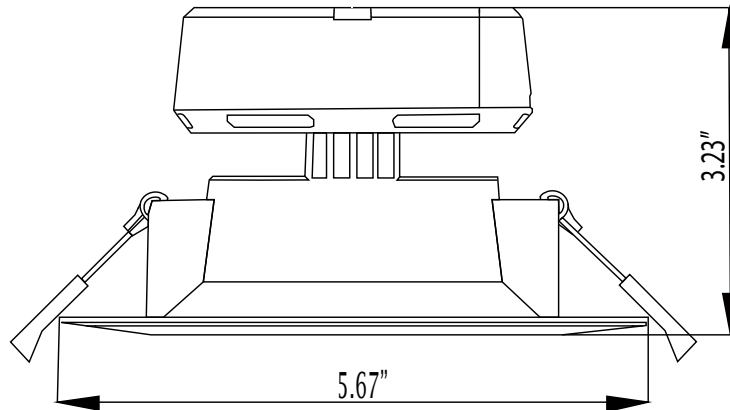

CONSTRUCTION

Housing
Plastic

Junction Box
Integrated

Trim Ring
Plastic Baffle

Retention Clips
Metal

PHYSICAL SPECIFICATIONS

Aperture Size
2.7"

Lens Type
Frosted

Lens Material
Polycarbonate

MODEL :		TYPE
PROJECT :		
PREPARED BY :	DATE :	

ELECTRICAL SPECIFICATIONS

Input Voltage
120 VAC

Efficacy
90+ lm/W

Color Temp
3000K

Frequency
60 Hz

CRI
> 80

LED Lifespan
40000 Hrs

Input Wattage
7 W

Input Current
0.07 A

Duv (CIE 1976)
-0.0006

Power Factor
> 0.9

Dimmable
5-100%*

Lumens
600+ lm

Beam Angle
108°

*Please consult approved dimmer list

PERFORMANCE SPECIFICATIONS

SPECTRAL POWER DISTRIBUTION & CHROMATICITY DIAGRAM

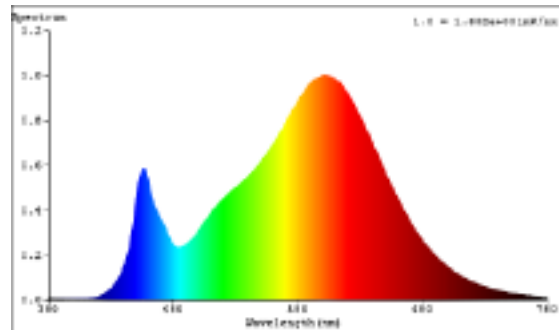

LUX DISTANCE CURVE

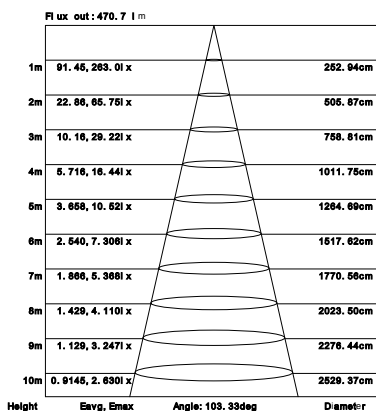

ZONAL LUMEN SUMMARY

ZONE	LUMEN	LUMINAIRE %
0-30	187.05	29.60
0-40	303.94	48.20
0-60	529.6	83.90
60-80	98.95	15.70
0-80	628.54	99.60
90-120	0.02	0.00
0-90	631.09	100.00
90-180	0.02	0.00
0-180	631.10	100.00

MODEL :		TYPE
PROJECT :		
PREPARED BY :	DATE :	

PHOTOMETRIC ISOLINES

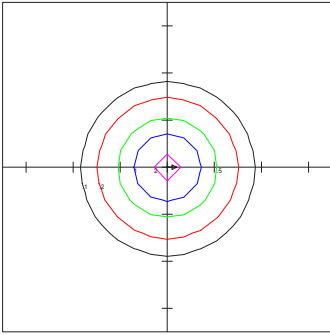

TAMLITE LIGHTING DELUCE
 IC4IJ-3
 Horizontal Footcandles
 Scale: 1 Hash = 10 Ft.
 Light Loss Factor = 1.00
 Lumens Per Lamp = 631.10
 Total Lamp Lumens = 631.10
 Mounting Height = 10 Ft.
 Arrangement: Single

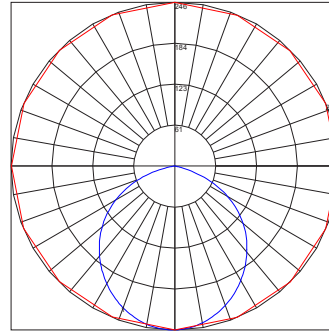

Polar Graph
 Maximum Candela = 245.73
 Located at
 Horizontal Angle = 270.00
 Vertical Angle = 1.00
 Vertical Plane Through Horizontal
 Angles
 (270 - 90)
 Horizontal Cone Through Vertical
 Angle
 (1.00)

CERTIFICATIONS/WARRANTY

Listing
 UL Listed

Location Rating:
 Suitable for Wet locations

Rating
 IC Rated

Warranty
 Guaranteed for three years from the purchase date of the product, against mechanical defects in manufacturing.

ORDERING INFORMATION

Sample Part Number: IC4IJ-3

Carton Dimensions: 15.8x16x9.5CM
 6.22x6.30x3.74IN

Case Dimensions: 48.9x39.2x16.5CM
 19.25x15.43x6.50IN

Case Quantity: 12 PCS

IC	4	IJ	-3
SERIES	SIZE	TYPE	COLOR TEMP
IC	[4] : 4"	[IJ] : Integrated J-Box	[-3] : 3000K

MODEL :		TYPE
PROJECT :		
PREPARED BY :	DATE :	

APPROVED DIMMER LIST

Legrand Dimmers				
DLV703-PLA	D703-PTC	DCL453-PTC	CDLV703-PW	CD703-PW
CDLV703-PW	D703-PTC	DLV703-PLA	HCL453PTCCCV6	H703PTCCCV6
Lutron Dimmers				
TGCL-153P	TG-600PNLH	S-600	LGCL-153PL	GL-600H
AYCL-153P	TG-600PHLH	TGCL-153P	DVCL-153PL	MA-600P
DVCL-153PL	TT-300	DV-603PG	GL-600H	MACL-153M
DVLV-600	LGCL-153PL	DVCL-153P	GTJ-250M	NELV-450
SELV-300P	DVELV-300P			
Leviton Dimmers				
6674	6672	6674	6613-P	6631
Cooper Dimmers				
DLC03P	9530WS			

