



CONTRACTOR:	
PROJECT:	DATE:
PREPARED BY:	MODEL#:

**DESCRIPTION**



**TCLED series**

The TCLED series of commercial grade luminaires is designed for general illumination in commercial, industrial and retail lighting applications. The 3" housing design makes this fixture series a great fit for all lighting applications.



**FEATURES AND SPECIFICATIONS**

**Intended Use**

The TCLED LED recessed troffer series provides all of the great benefits of an LED luminaire, while maintaining the familiar look of traditional linear fluorescent troffer. This allows for a seamless transition to LED without disrupting the look of the overall space. These benefits make the TCLED a great choice for school, office, retail, residential and hospital applications. Certain airborne contaminants can diminish integrity of acrylic.

**Construction**

Full unibody construction along with chamfered corners and powder coat after fabrication allows for safe, easy installation. The shallow depth of 3" allows for easier installations into restricted plenum applications. The body is constructed of 24 gauge, made in USA commercial grade steel with hot dip galvanized finish (6.5µm on both sides). Finish: Paint after fabrication (PAF) of galvanized body adds high resistance to rust over its lifetime.

**Optics**

Highly transmissive prismatic pattern (0.095" thickness) P1 lens helps to diffuse the LED source pixilation, without compromising light output.

**Electrical**

Long-life LEDs PCB mounted, coupled with high-efficiency drivers, provide extended service life. The TCLED delivers up to 131 lumens per watt and LED Lumen maintenance of L80/60,000 hours.

**Dimming**

0-10V dimming. Consult factory for dim to off, auxiliary power 12/20/24Vdc and 0-10V step dimming to programmable levels.

**Installation**

Drivers and internal components are accessible from the floor in standard products. LED boards include plug-in connectors for future upgrades. Damp location listed. Not intended for continuous row mounting.

**Listings**

UL listed to US and Canadian safety standards. Damp location listed. For use in ambient operating temperatures ranging from -40°C to 40°C.

**Warranty**

5-year limited warranty.

**IMPORTANT:** In order to maintain proper operation and warranty coverage for units with Emergency back up, the battery must be recharged once per year prior to installation.

**NOTE:** Actual performance may differ as a result of end-user environment and application. All values are design or typical values, measured under laboratory conditions at 25 °C. Specifications subject to change without notice.

**LINE DRAWING**

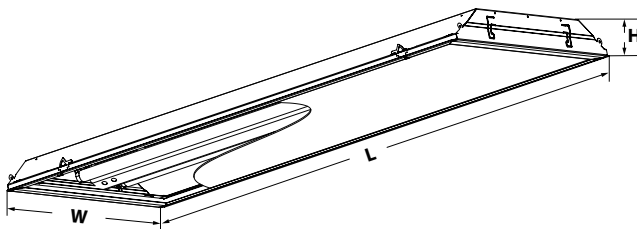

SIZE	W	H	L
2'x2'	23.75"	3"	23.88"
2'x4'	23.75"	3"	47.69"

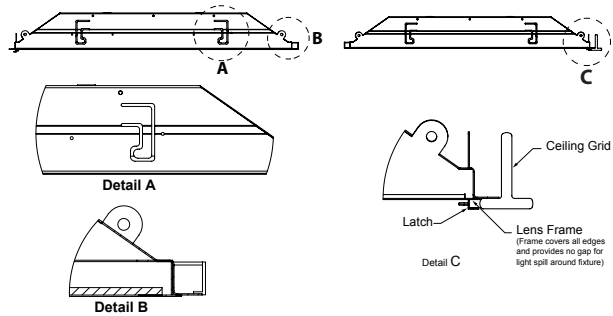

APPLICATION AND PERFORMANCE SPECIFICATION IS SUBJECT TO CHANGE WITHOUT NOTIFICATION



CONTRACTOR:	
PROJECT:	DATE:
PREPARED BY:	MODEL#:

**ORDERING INFORMATION**

EXAMPLE: TCLED22-40DP1L840

SERIES	SIZE	LUMENS	VOLTAGE	LENS	CRI	COLOR TEMP	OPTIONS	EMERGENCY	FINISH
TCLED	[22] : 2'x 2' [24] : 2'x 4'	[-30] : 3000 Lumens [-40] : 4000 Lumens [-50] : 5000 Lumens [-60] : 6000 Lumens [-70] : 7000 Lumens [-80] : 8000 Lumens [-90] : 9000 Lumens [-100] : 10000 Lumens [-175] : 17500 Lumens [-200] : 20000 Lumens	[D] : 120-277VAC [E] : 277-480VAC	[Blank] : No Door [P1] : 0.080 Prismatic Acrylic [P2] : 0.125 Prismatic Acrylic [LC1] : 0.080 Clear Acrylic [LF1] : 0.080 Frosted Acrylic	[L8] : CRI±80	[35] : 3500K [40] : 4000K [50] : 5000K	[BLANK] : No Option [-F] : Fuse [-W6-3] : Flex Wip-6 3 Wire* [-W6-3DIM] : Flex Wip-6 3 Wire Dim* [-WG] : Wire Guard	[BLANK] : No Option [-EM] : 10% Emergency back-up	[Blank] : White [-BK] : Black

\*Other whip, cord and plug options available, contact factory for details.

**PERFORMANCE SPECIFICATIONS**

PART#	LUMEN PACKAGE	LUMENS	LPW	LUMENS	LPW	LUMENS	LPW	LUMENS	LPW	MAX WATTAGE
		@ 3000K		@ 3500K		@ 4000K		@ 5000K		
TCLED22-30	3000	3464	98	2740	102	2876	109	2877	109	35.51
TCLED22-40	4000	3609	96	3609	96	3784	102	3808	102	37.49
TCLED22-50	5000	4585	96	4580	95	4865	102	4843	102	48.03
TCLED22-60	6000	5437	94	5440	94	5782	100	5705	99	58.15
TCLED22-70	7000	6628	93	6537	92	6931	99	6961	98	71.48
TCLED22-80	8000	7419	94	7341	93	7819	100	7829	99	79.33
TCLED22-90	9000	8712	96	8626	95	9097	101	9205	102	90.82
TCLED22-100	10,000	9503	94	9490	93	9922	99	10041	100	101.8
TCLED24-30	3000	2768	120	2880	124	2999	131	3003	131	23.18
TCLED24-40	4000	3924	117	3899	116	4134	124	4163	125	33.68
TCLED24-50	5000	4675	107	4954	115	5183	122	5228	123	43.77
TCLED24-60	6000	5802	110	5973	113	6296	121	6314	121	52.86
TCLED24-70	7000	6360	105	6451	113	6769	121	6815	121	60.56
TCLED24-80	8000	7888	109	7940	110	8463	118	8490	118	72.53
TCLED24-90	9000	8746	107	9004	108	9322	116	9468	117	83.16
TCLED24-100	10,000	9861	107	9868	106	10253	114	10443	115	92.73

APPLICATION AND PERFORMANCE SPECIFICATION IS SUBJECT TO CHANGE WITHOUT NOTIFICATION



CONTRACTOR:		DATE:
PROJECT:		
PREPARED BY:	MODEL#:	

**PHOTOMETRIC REPORTS**

**Polar Graph**

IES ROAD REPORT  
PHOTOMETRIC FILENAME : TCLED22-70D1P1L840.IES  
POLAR GRAPH

2'x2'

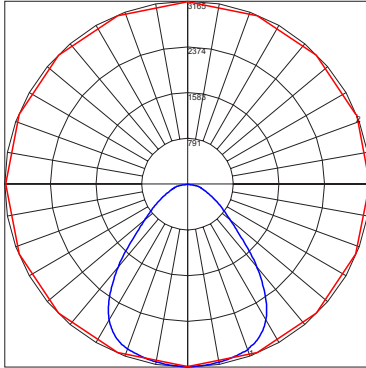

Maximum Candela = 3165 Located At Horizontal Angle = 90, Vertical Angle = 2  
# 1 - Vertical Plane Through Horizontal Angles (90 - 270) (Through Max. Cd.)  
# 2 - Horizontal Cone Through Vertical Angle (2) (Through Max. Cd.)

**Luminaire Classification Graph**

IES ROAD REPORT  
PHOTOMETRIC FILENAME : TCLED22-70D1P1L840.IES  
ISOFOOTCANDLE LINES OF HORIZONTAL ILLUMINANCE

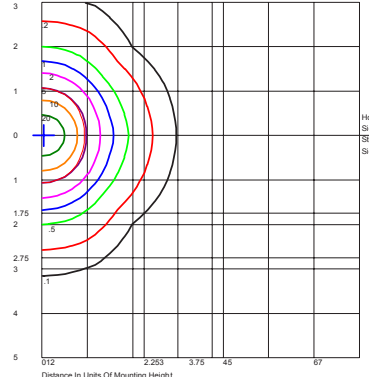

Distance In Units Of Mounting Height  
Values Based On 10 Foot Mounting Height  
1/2 Maximum Candela Trace Shown As Dashed Curve  
(\*) = Maximum Candela Point

**Isocandela Plot**

IES ROAD REPORT  
PHOTOMETRIC FILENAME : TCLED22-70D1P1L840.IES  
LUMINAIRE CLASSIFICATION SYSTEM (LCS) GRAPH

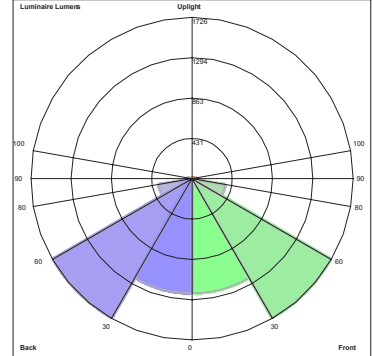

Luminaire Lumens:  
Front: Low=1233.1, Medium=1725.6, High=370.7, Very High=63.7  
Back: Low=1233.1, Medium=1725.6, High=370.7, Very High=63.7  
Uplight: Low=0.3, High=0.0  
BUG Rating : B3-U1-G1

2'x4'

IES ROAD REPORT  
PHOTOMETRIC FILENAME : TCLED24-70D1P1L830.IES  
POLAR GRAPH

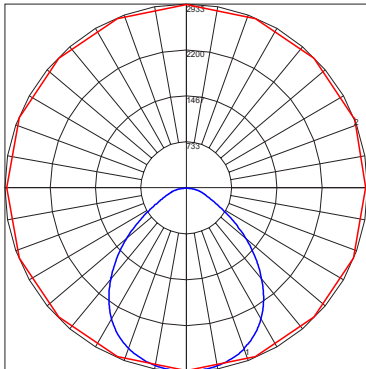

Maximum Candela = 2933 Located At Horizontal Angle = 22.5, Vertical Angle = .5  
# 1 - Vertical Plane Through Horizontal Angles (22.5 - 202.5) (Through Max. Cd.)  
# 2 - Horizontal Cone Through Vertical Angle (.5) (Through Max. Cd.)

IES ROAD REPORT  
PHOTOMETRIC FILENAME : TCLED24-70D1P1L830.IES  
ISOFOOTCANDLE LINES OF HORIZONTAL ILLUMINANCE

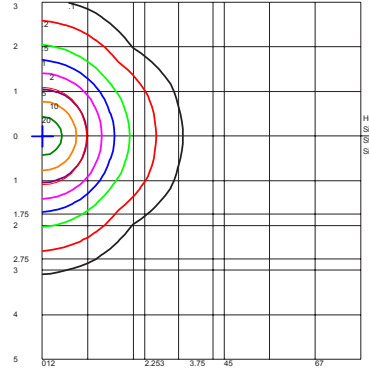

Distance In Units Of Mounting Height  
Values Based On 10 Foot Mounting Height  
1/2 Maximum Candela Trace Shown As Dashed Curve  
(\*) = Maximum Candela Point

IES ROAD REPORT  
PHOTOMETRIC FILENAME : TCLED24-70D1P1L830.IES  
LUMINAIRE CLASSIFICATION SYSTEM (LCS) GRAPH

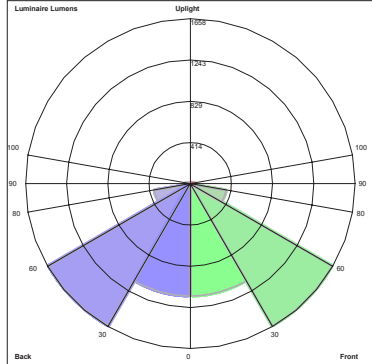

Luminaire Lumens:  
Front: Low=1134.2, Medium=1657.6, High=373.8, Very High=61.2  
Back: Low=1134.2, Medium=1657.6, High=373.8, Very High=61.2  
Uplight: Low=0.6, High=0.0  
BUG Rating : B3-U1-G1