

**INSTALLATION**

## CH-WSCS-WH-UZTD-G2

### Wattage & Color Selectable Retro Downlight

LED Recessed Kit is designed to be installed in a standard CFL mounting frame.

LED Retrofit kit includes: LED module (1), Conduit with connector (1), Wire nuts (5)

This LED retrofit kit is certified Air Tight in compliance with restricted airflow requirements in accordance with ASTM-E283 standard. An EVA gasket is already installed on the kit in order to ensure an airtight installation.

Note: Not all existing mounting frames will be compatible with the LED Kit. To ensure compatibility, a test installation should be conducted.

**WARNING**

To avoid personal injury and/or possible product damage, the following cautions must be followed:

- Risk of electrical shock. Disconnect power at fuse or circuit breaker before installing or servicing.
- To prevent early lamp failure, lamp should only be installed in operating environments ranging between -20°C and +40°C (-4°F and +104°F).
- No user serviceable parts inside. To avoid electrical shock do not disassemble product.
- This product is not intended for use in emergency light fixtures or exit signs.
- Suitable for wet locations.
- **WARNING** – Risk of fire or electric shock. LED Retrofit Kit installation requires knowledge of luminaires electrical systems. If not qualified, do not attempt installation. Contact a qualified electrician.
- Covered ceiling only.

**CAUTION**

- To prevent electrical shock, turn power off before inspection, installation or removal.
- Use only on 120-277 VAC, 50/60Hz circuits.

**NOTE:** This equipment has been tested and found to comply with the limits for a Class A digital device, pursuant to part 15 of the FCC Rules. These limits are designed to provide reasonable protection against harmful interference when the equipment is operated in a commercial environment. This equipment generates, uses, and can radiate radio frequency energy and, if not installed and used in accordance with the instruction manual, may cause harmful interference to radio communications. Operation of this equipment in a residential area is likely to cause harmful interference in which case the user will be required to correct the interference at his own expense. This Class A digital apparatus complies with Canadian ICES-005.

**INSTALLATION INSTRUCTIONS**
**LED kit installation with existing frame**

**Step 1:** Shut power OFF to the fixture.

**Step 2:** Remove CFL, Incandescent or HID lamp.

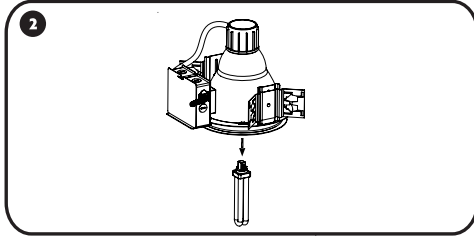

**Step 4:** Remove socket assembly from reflector.

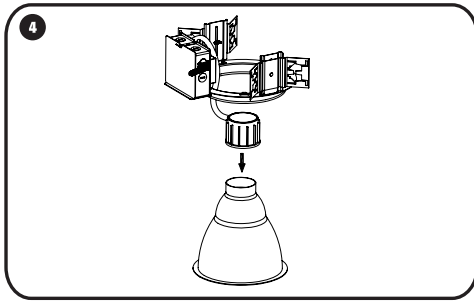

**Step 6:** Remove the existing lamp metal conduit (MC) cable from the J-Box.

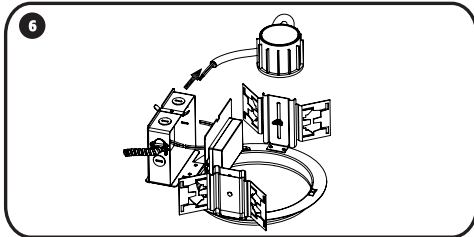

**Step 8:** Fasten the LED retrofit kit MC cable to the J-Box.

**Step 3:** Remove reflector from rough-in (mounting frame).

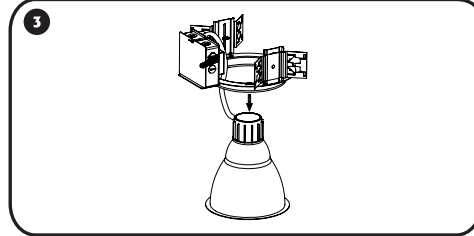

**Step 5:** Remove J-Box metal plate with existing lamp ballast. Do not dispose. Disconnect all wires from the ballast.

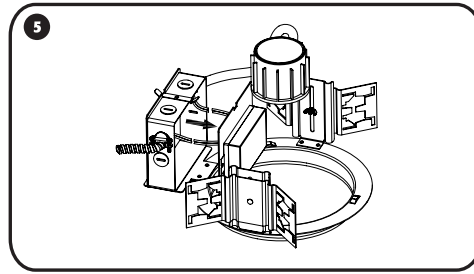

**Step 7:** Select desired lumen and CCT level using switch on driver box.

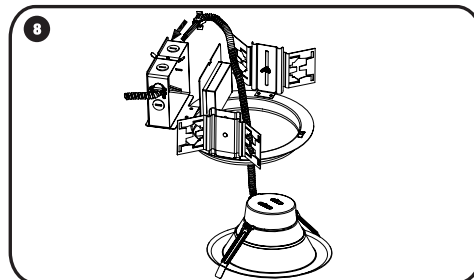
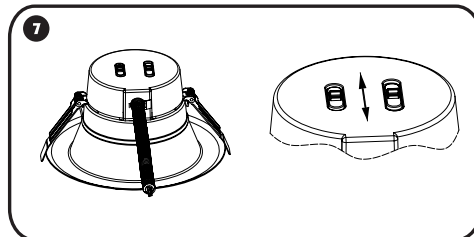

**INSTALLATION INSTRUCTIONS**

**Step 9:** Wire nut the ground (green) wire in the junction box. Wire nut the black input wire with the black wire from the MC cable and wire nut the white input wire with the white wire from the MC cable. Wire nut the purple input wire with the purple wire from the MC cable and wire nut the pink input wire with the pink wire from the MC cable. If the purple and pink wires are not in use, cap these wires individually with wire nuts.

**Step 10:** Install the junction box cover plate (with lamp ballast still attached to it).

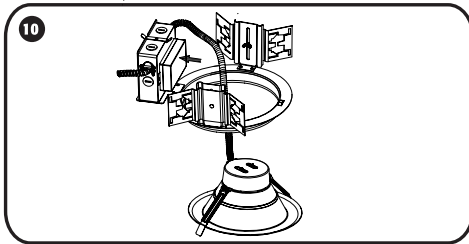

**Step 12:** Turn power ON and start saving \$\$.

**LED kit installation without existing frame**

**Step 1:** Select desired lumen and CCT level using switch on driver box.

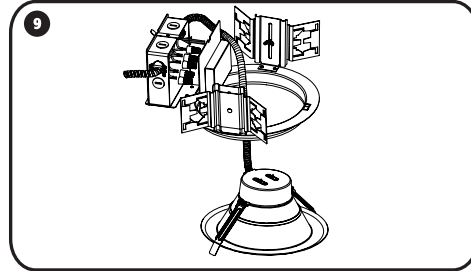

**Step 11:** Install the retrofit kit in the rough-in by lifting upward both retention tabs. Push the kit until it sits flush against the ceiling.

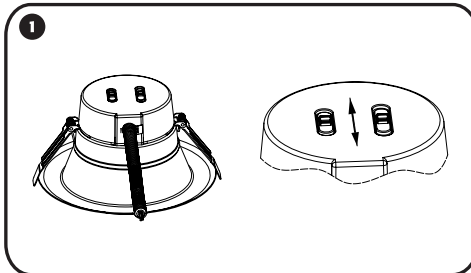
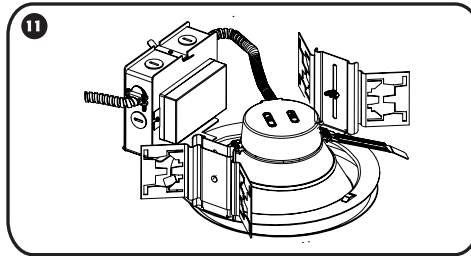

**Step 2:** Shut power OFF to the fixture. Fasten the LED kit MC cable to a junction box. Wire nut the ground (green) wire in the junction box. Wire nut the black input wire with the black wire from the MC cable and wire nut the white input wire with the white wire from the MC cable. Wire nut the purple input wire with the purple wire from the MC cable and wire nut the pink input wire with the pink wire from the MC cable. If the purple and pink wires are not in use, cap these wires individually with wire nuts.

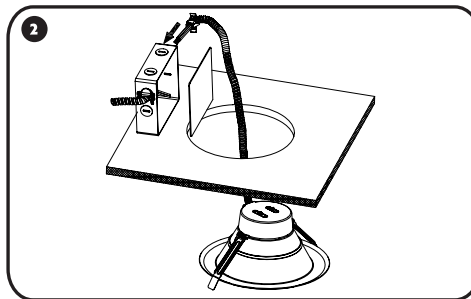

**INSTALLATION INSTRUCTIONS**

**Step 3: Install junction box cover plate.**

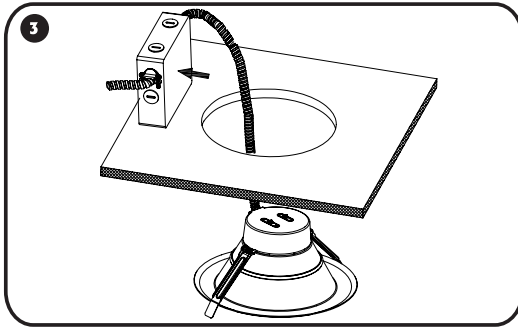

**Step 4 & 5: Install the LED kit by lifting both retention tabs upward. Push the kit until it sits flush against the ceiling.**

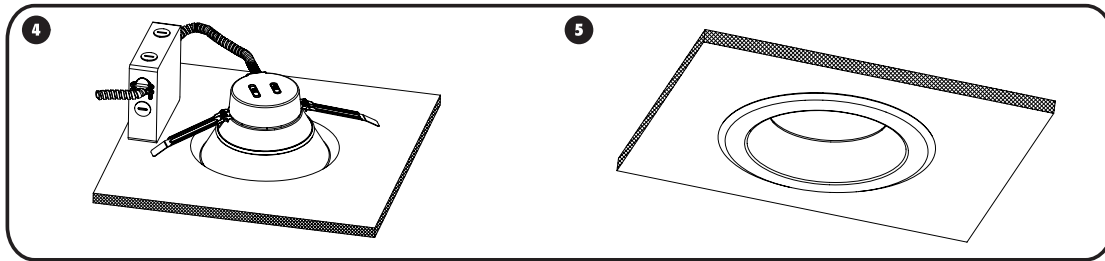
**LED RECESSED DOWNLIGHT KIT LIMITED WARRANTY**

The manufacturer warrants this Product to be free from defects in material or workmanship for 5 years from purchase date, when used as directed. This warranty does not cover accidents, abuse, acts of God, use in violation of law or electrical standards, or damage from primary side power sources (e.g., short circuits/power surges). The manufacturer may examine the Product to determine if Product is defective prior to providing a replacement. If Product has a defect in materials or workmanship, the manufacturer will replace it with the same or similar Product at no charge. **LABOR IS NOT INCLUDED.** In the United States, Product should be returned with proof of purchase date to the retail store where purchased.