



CONTRACTOR:	
PROJECT:	DATE:
PREPARED BY:	MODEL#:

DESCRIPTION



IBLED Series

The IBLED series LED high bays are ideal for manufacturing, warehousing, commercial and industrial facility lighting applications. The superior design makes it a sturdy, user friendly and easy to install high bay. The patented curved housing helps provide superior light distribution.



CONSTRUCTION/WARRANTY

Intended Use

Applications include large indoor spaces with mounting heights ranging from 10' - 75'. Luminaire shall be suspended a minimum 18" from ceiling.

Construction

The body is constructed of 24 gauge, made in USA commercial grade steel with hot dip galvanized finish (6.5µm on both sides). Wire guard installed as standard to protect LEDs from damage- can be removed after installation.

Finish: Paint after fabrication (PAF) of galvanized body adds high resistance to rust over its lifetime. This also eliminates sharp edges on the body.

Optics

Patented design delivers excellent distribution for warehouse applications. Semi-diffused lens optional to provide glare control and LED protection.

Electrical

70% lumen maintenance at >60,000 hours; predicted life of more than 100,000 hours. Long-life LEDs PCB mounted, coupled with high-efficiency drivers, provide extended service life. Thermally protected driver standard.

Dimming

LED drivers deliver dimming from a 0-10V control signal. Requires separate 0-10V DC dimming circuit. Dims down to 0% light output.

Installation

Suitable for suspension by chain, cable, surface-mounting bracket, V-hook or single (pendant) point. Surface mounting not recommended without optional surface mounting bracket.

To maintain ambient listing, fixture should be mounted at a minimum plenum height of 18".

Listings

UL listed to US and Canadian safety standards. Damp location listed. Suitable for use in an indoor conditioned space. DesignLights Consortium® (DLC) qualified product. Not all versions of this product may be DLC qualified. Please check the DLC Qualified Products List at www.designlights.org/QPL to confirm which versions are qualified.

Warranty

Guaranteed for five years from the purchase date of the product, against mechanical defects in manufacturing.

IMPORTANT: In order to maintain proper operation and warranty coverage for units with Emergency back up, the battery must be recharged once per year prior to installation.

NOTE: Actual performance may differ as a result of end-user environment and application. All values are design or typical values, measured under laboratory conditions at 25 °C. Specifications subject to change without notice.

LINE DRAWINGS

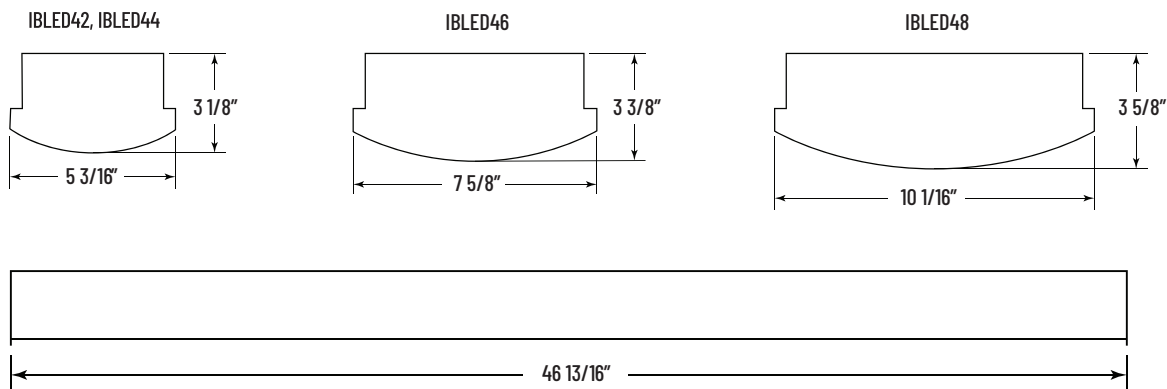

APPLICATION AND PERFORMANCE SPECIFICATION IS SUBJECT TO CHANGE WITHOUT NOTIFICATION



CONTRACTOR:	
PROJECT:	DATE:
PREPARED BY:	MODEL#:

ORDERING INFORMATION

Example: IBLED44-150DL840

SERIES	SIZE & LUMENS	VOLTAGE	CRI	COLOR TEMP	OPTIONS	EMERGENCY	FINISH
IBLED	[23-150] : 2ft, 15000 Lumens	[D] : 120-277VAC [E] : 277-480VAC	[L8] : CRI 80+	[40] : 4000K [50] : 5000K	[BLANK] : No Option [OS] : Occupancy sensor [LF] : Frosted Lens [LC] : Clear Polycarb Lens [HT] : Hanging Triangle [W6-3] : Flex Whip-6' 3 Wire** [W6-515] : Cord-6' SJ-515 Plug**	[BLANK] : No Option [EM] : 10% Emergency back-up	[BLANK] : White [BK] : Black [RAL] : Custom Color*
	[24-150]: 2ft, 15000 Lumens						
	[26-200] 2ft, 20000 Lumens						
	[26-250]: 2ft, 25000 Lumens						
	[42-100] : 4ft, 10000 Lumens						
	[44-150] : 4ft, 15000 Lumens						
	[44-200] : 4ft, 20000 Lumens						
	[44-250] : 4ft, 25000 Lumens						
	[46-350] : 4ft, 35000 Lumens						
	[48-500] : 4ft, 50000 Lumens						

* MOQ Required, contact factory for details.

** Other whip, cord and plug options available, contact factory for details.

LIGHTING & ELECTRICAL SPECIFICATIONS

SERIES	DELIVERED LUMENS	LPW	POWER CONSUMPTION (WATTS)
[IBLED 44-200]: 4ft, 20,000Lm	19,874	166	116
[IBLED 44-250]: 4ft, 25,000Lm	24,082	151	158
[IBLED 44-200]: 4ft, 20,000Lm	19,372	166	116
[IBLED 46-350]: 4ft, 35,000Lm	35,658	155.44	229
[IBLED 48-500]: 4ft, 50,000Lm	49,749	157	315



CONTRACTOR:	
PROJECT:	DATE:
PREPARED BY:	MODEL#:

DRIVER INFORMATION

ELECTRICAL SPECIFICATIONS

Input	
Frequency Range (Hz)	50-60 Hz
Efficiency @ Full Load	>87
Power Factor @ Full Load	>0.9
Output	
Dimming Control 0-10V	0-100%
Over Voltage Protection	YES
Over Load Protection	YES
Over Temperature Protection	YES
Output Short-Circuit Protection	YES

ENVIRONMENTAL SPECIFICATIONS

Ambient Operating Temperature	-22°F to 104°F
Listings	Suitable for Dry and Damp Locations

PHOTOMETRIC REPORTS

IBLED43-200D1L840

IES TM-15-11 BUG Ratings

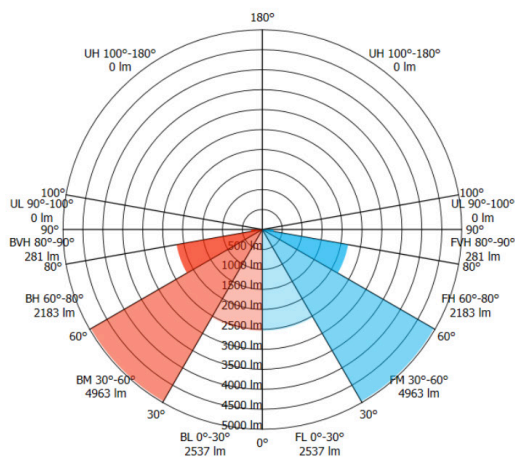

Candela Polar Plot

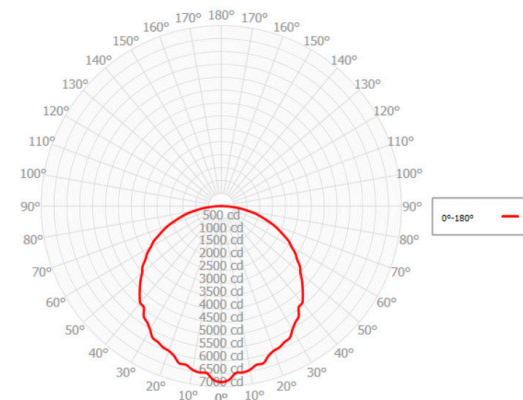

APPLICATION AND PERFORMANCE SPECIFICATION IS SUBJECT TO CHANGE WITHOUT NOTIFICATION



CONTRACTOR:	
PROJECT:	DATE:
PREPARED BY:	MODEL#:

ACCESSORIES MECHANICAL/OPTICAL



Wire Guard
Comes standard



Clear Polycarb Lens



Frosted Lens

Wire Guards and Lenses

MODELS	FROSTED LENS	CLEAR POLYCARB LENS
IBLED42 IBLED44	IBLED4-LF	IBLED4-LC
	<p>Lens</p>	<p>Wire guard</p>
IBLED46	IBLED6-LF	IBLED6-LC
	<p>Lens</p>	<p>Wire guard</p>
IBLED48	IBLED8-LF	IBLED8-LC
	<p>Lens</p>	<p>Wire guard</p>



APPLICATION AND PERFORMANCE SPECIFICATION IS SUBJECT TO CHANGE WITHOUT NOTIFICATION



CONTRACTOR:	
PROJECT:	DATE:
PREPARED BY:	MODEL#:

ACCESSORIES

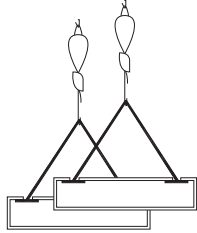
Sold Separately

Aircraft Cable Hangers	10 FT	TAMGRIP-10FT-KIT (0553-3296)	
	30 FT	HB-2PK-30FT (0539-1045)	
High Bay V-Hangers Single point suspension that allows two points to be suspended. Two legs improve center of gravity and increases stability. Ideal for services that require maintenance.	N/A	HB-4L-VHANGER (0392-3559)	
	N/A	HB-6L-VHANGER (0322-9989)	
Pendant Mount Splice Box Single point hanging box splice box with 3/4" NPT mount with up to 1-1/2" off center balance adjustment. Dimensions: 2-3/16" x 4-1/2" x 4-1/2"	PD-SPLICEBOX (0296-0937)		
Surface Mount Bracket Material: 24 gauge hot dipped galvanized steel. Finish: Powder Coat paint after fabrication of the galvanized bracket also means that this fixture is highly resistant to rust over its lifetime.	IBLED24, IBLD26	TW-IB82-KIT (0607-5033)	
	IBLED42, IBLD43, IBLD44, IBLD46	TW-IB4-KIT (0587-5365)	
	IBLED48	TW-IB8-KIT (0587-5368)	

SENSOR OPTIONS

Occupancy Sensor

OSFHU Passive Infrared Fixture Mount High Bay Occupancy Sensor